

REVISIONS				
ZONE	REV.	DESCRIPTION	DATE	APPROVED
	3	50" X-AXIS TRAVEL_8" Z-AXIS TRAVEL	1/29/13	RL

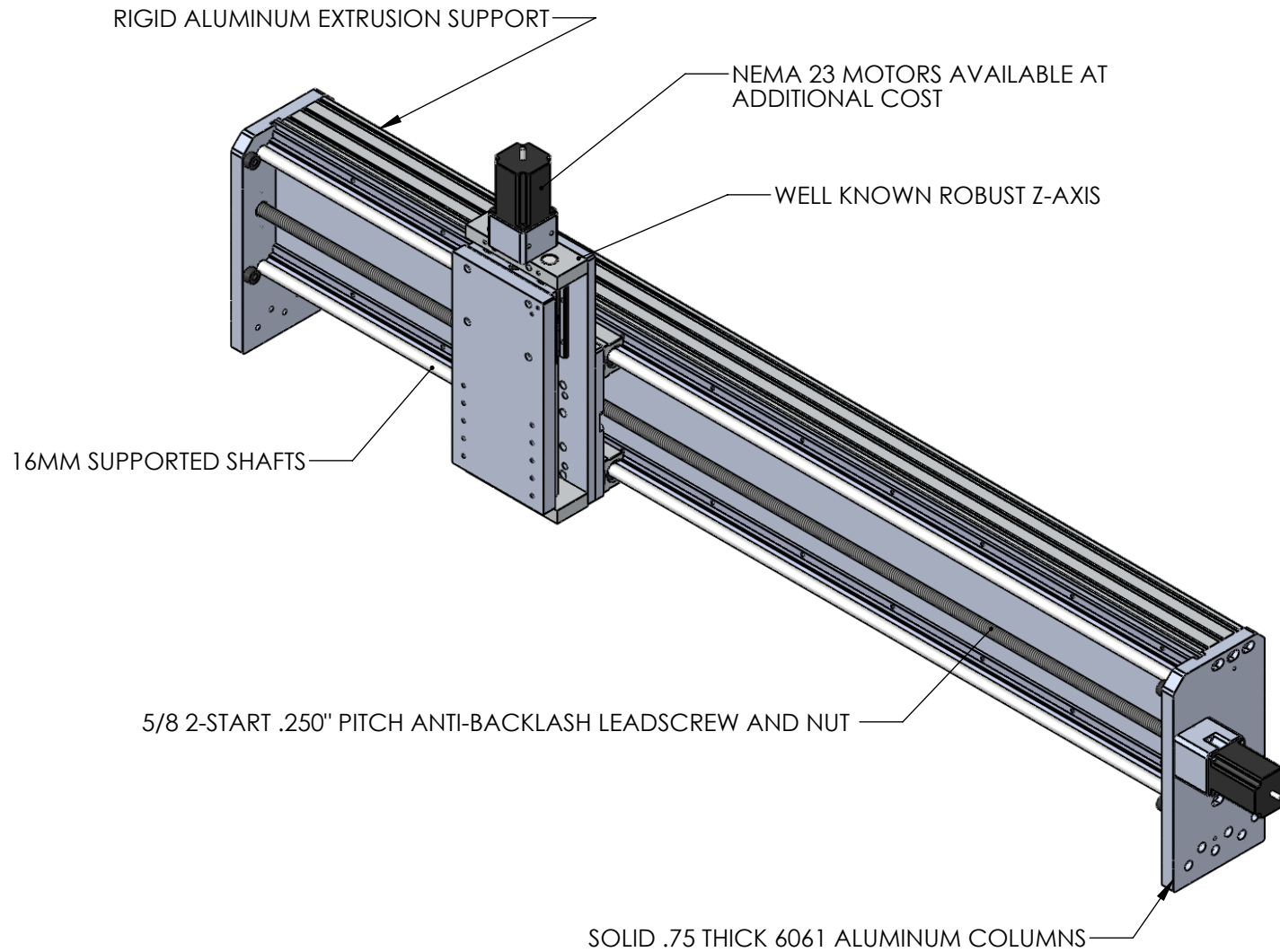

UNLESS OTHERWISE SPECIFIED:	NAME	DATE
DIMENSIONS ARE IN INCHES	DRAWN	CP
FILLETS AND ROUNDS R	CHECKED	RL
HOLES THROUGH ALL	ENG APPR.	
	MFG APPR.	
INTERPRET GEOMETRIC TOLERANCING PER:	Q.A.	
MATERIAL	COMMENTS:	
6061 ALLOY		
FINISH		
DO NOT SCALE DRAWING		

VELOX CNC		
TITLE: XZ COMBO SERIES		
SIZE	DWG. NO.	REV
A	XZ_Combo Master REV 2	3
SCALE: 1:8	WEIGHT:	SHEET 1 OF 10

REVISIONS				
ZONE	REV.	DESCRIPTION	DATE	APPROVED
	3	36" X-AXIS TRAVEL_8" Z-AXIS TRAVEL	1/29/13	RL

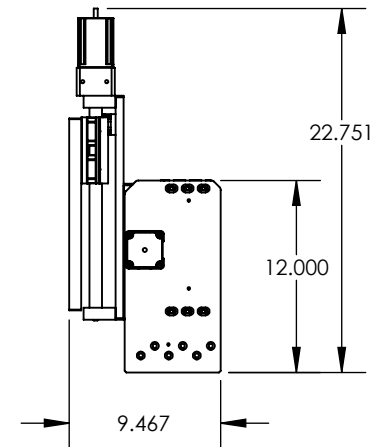
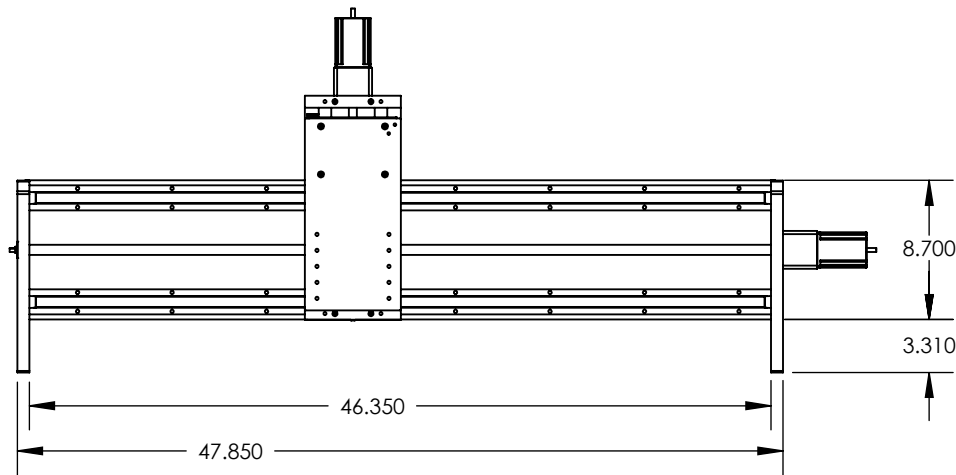
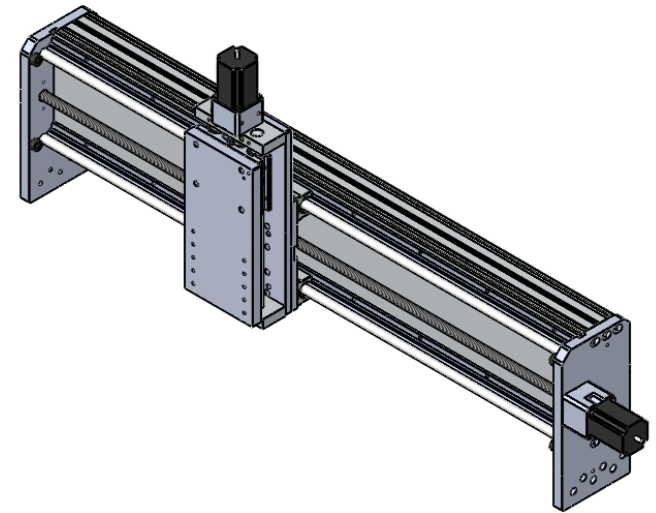
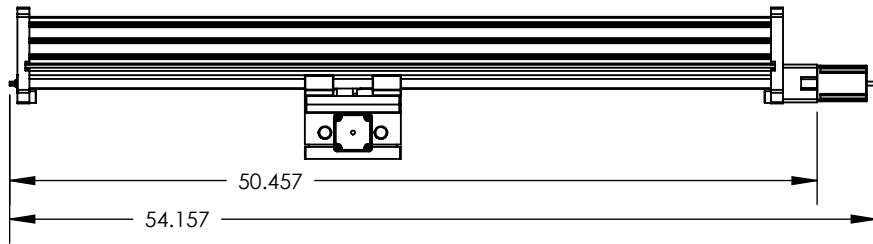

NEMA 23 MOTORS AVAILABLE AT ADDITIONAL COST



UNLESS OTHERWISE SPECIFIED:
 DIMENSIONS ARE IN INCHES
 FILLETS AND ROUNDS R
 HOLES THROUGH ALL
 INTERPRET GEOMETRIC TOLERANCING PER:
 MATERIAL 6061 ALLOY
 FINISH
 DO NOT SCALE DRAWING

	NAME	DATE
DRAWN	CP	
CHECKED	RL	
ENG APPR.		
MFG APPR.		
Q.A.		
COMMENTS:		

VELOX CNC		
TITLE:		
XZ-3600		
SIZE	DWG. NO.	REV
A	XZ_Combo Master REV 2	3
SCALE: 1:12	WEIGHT:	SHEET 6 OF 10

REVISIONS				
ZONE	REV.	DESCRIPTION	DATE	APPROVED
	3	FOR XZ COMBO SERIES	1/29/13	RL

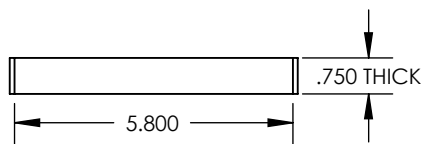
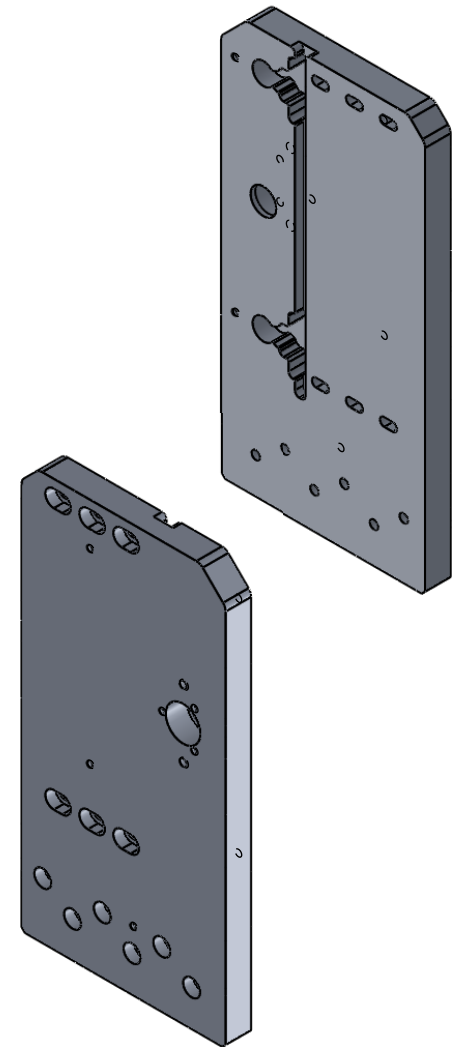
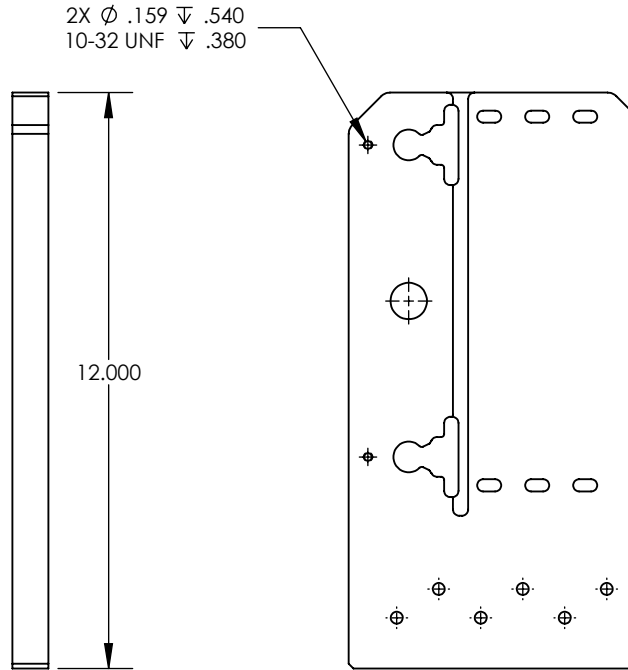
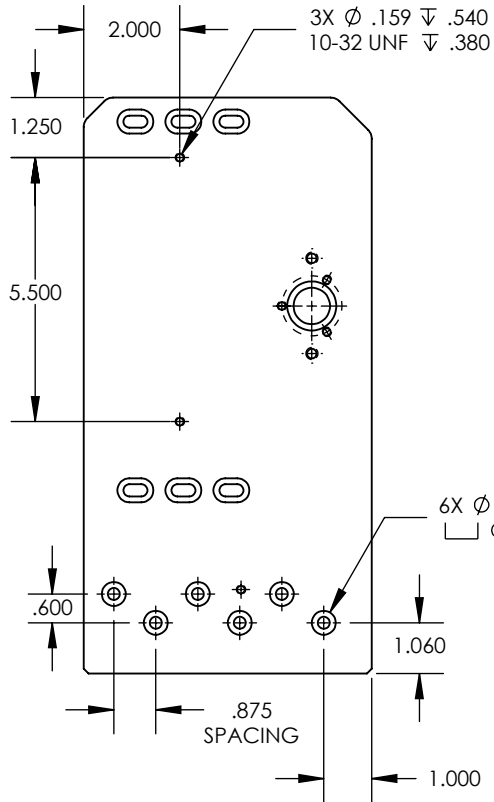
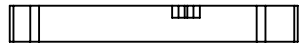

UNLESS OTHERWISE SPECIFIED:
 DIMENSIONS ARE IN INCHES
 FILLETS AND ROUNDS R
 HOLES THROUGH ALL
 INTERPRET GEOMETRIC TOLERANCING PER:
 MATERIAL 6061 ALLOY
 FINISH
 DO NOT SCALE DRAWING

	NAME	DATE
DRAWN	CP	
CHECKED	RL	
ENG APPR.		
MFG APPR.		
Q.A.		
COMMENTS:	RIGHT SIDE COLUMN	

VELOX CNC		
TITLE: STANDARD XZ COMBO COLUMN		
SIZE	DWG. NO.	REV
A	XZ_Combo Master REV 2	3
SCALE: 1:4	WEIGHT:	SHEET 8 OF 10