

REVISIONS				
ZONE	REV.	DESCRIPTION	DATE	APPROVED
P	1	INITIAL RELEASE	9/2012	RL
P	2	IMPROVED RIGIDITY AND SUPPORT	2/18/2013	RL

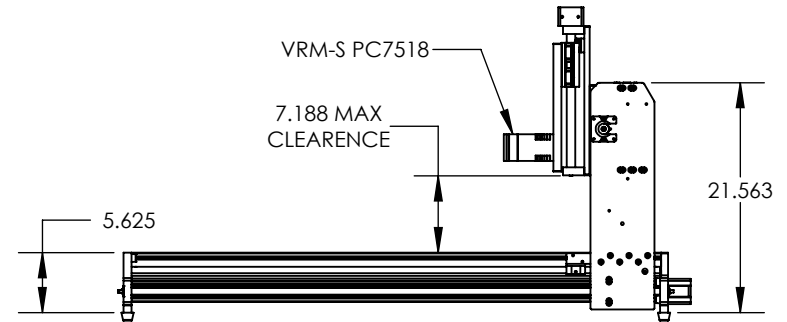
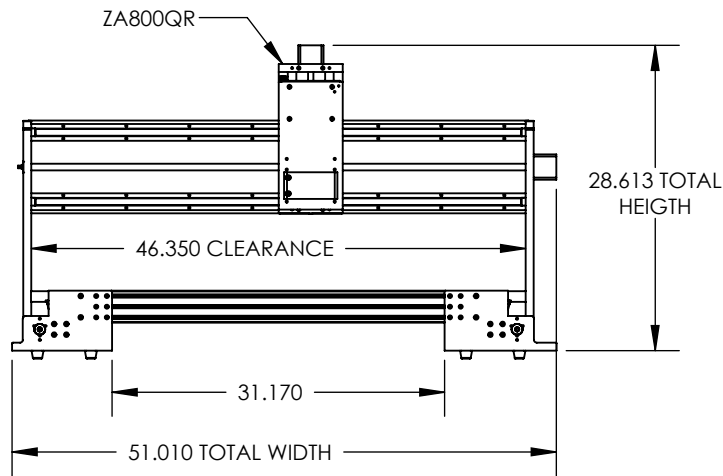
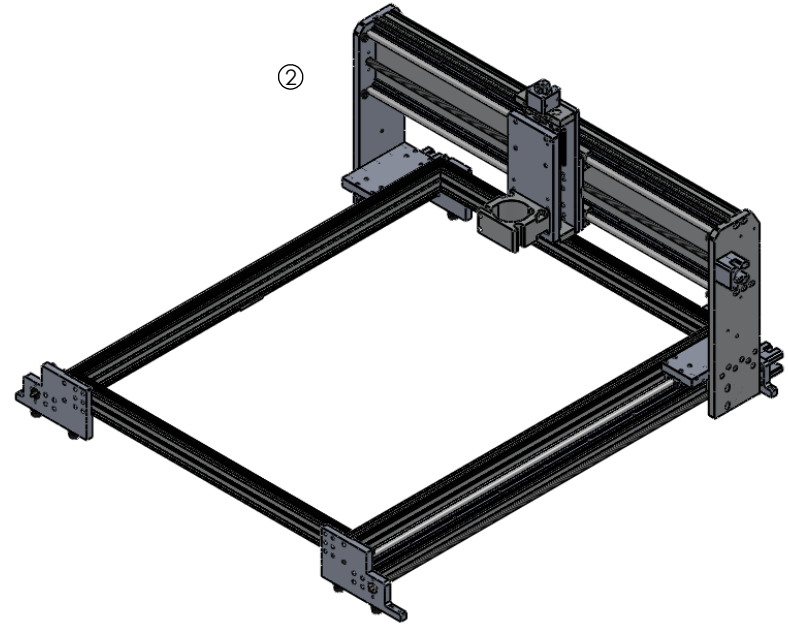

UNLESS OTHERWISE SPECIFIED: DIMENSIONS ARE IN INCHES FILLETS AND ROUNDS R HOLES THROUGH ALL INTERPRET GEOMETRIC TOLERANCING PER: MATERIAL VARIES FINISH DO NOT SCALE DRAWING	NAME	DATE
	DRAWN	CP
	CHECKED	RL
	ENG APPR.	
	MFG APPR.	
Q.A.		
COMMENTS:	X-AXIS TRAVEL: 36" Y-AXIS TRAVEL: 36" Z-AXIS TRAVEL: 8"	

VELOX CNC		
TITLE:		
KIT-3636		
SIZE	DWG. NO.	REV
A	VR-KIT 5050 Master	2
SCALE: 1:18 WEIGHT:		SHEET 4 OF 15