

REVISIONS				
ZONE	REV.	DESCRIPTION	DATE	APPROVED
P	1	INITIAL RELEASE	9/2012	RL
P	2	IMPROVED RIGIDITY AND SUPPORT	2/18/2013	RL

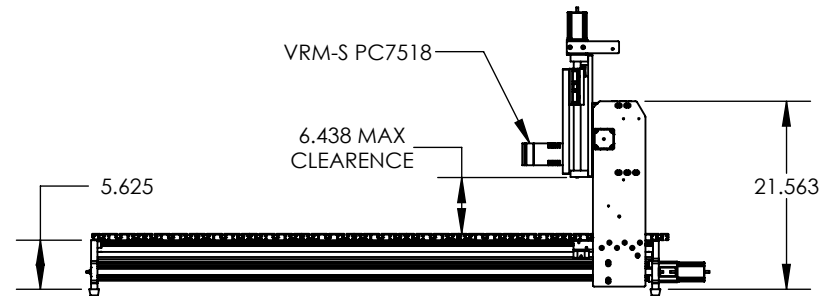
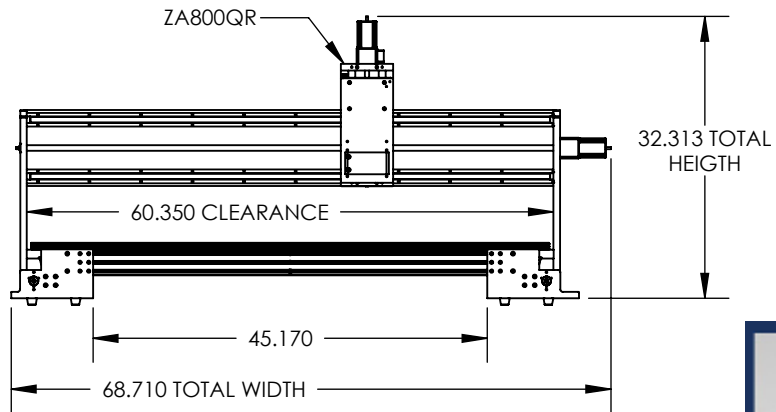
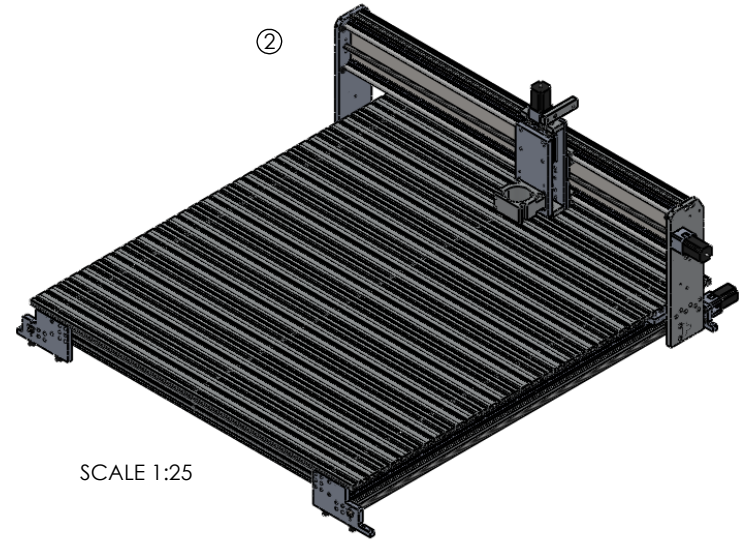

UNLESS OTHERWISE SPECIFIED:	NAME	DATE
DIMENSIONS ARE IN INCHES	DRAWN	CP
FILLETS AND ROUNDS R	CHECKED	RL
FILLES AND ROUNDS R	ENG APPR.	
HOLES THROUGH ALL	MFG APPR.	
INTERPRET GEOMETRIC TOLERANCING PER:	Q.A.	
MATERIAL VARIES	COMMENTS:	
FINISH	X-AXIS TRAVEL: 50"	
	Y-AXIS TRAVEL: 50"	
	Z-AXIS TRAVEL: 8"	
DO NOT SCALE DRAWING		

VELOX CNC		
TITLE:		
VR-5050		
SIZE	DWG. NO.	REV
A	VR-KIT 5050 Master	2
SCALE: 1:22	WEIGHT:	SHEET 1 OF 15