

REVISIONS				
ZONE	REV.	DESCRIPTION	DATE	APPROVED
	1	3" TRAVEL	8/8/12	RL

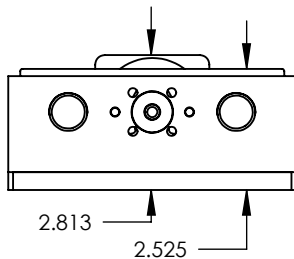
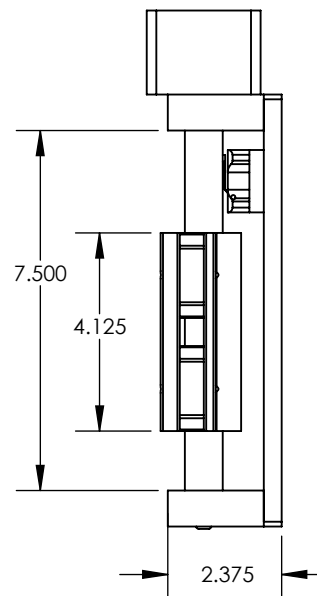
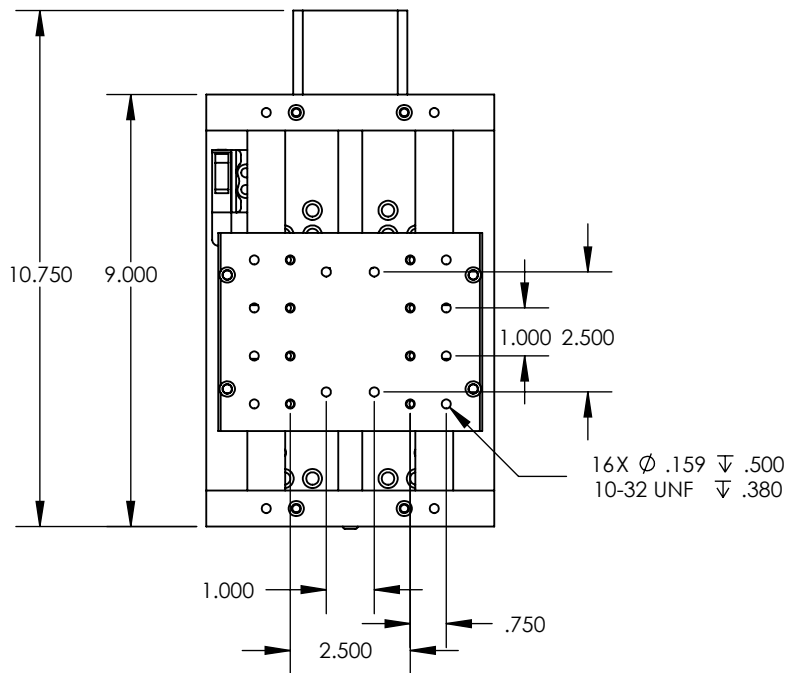
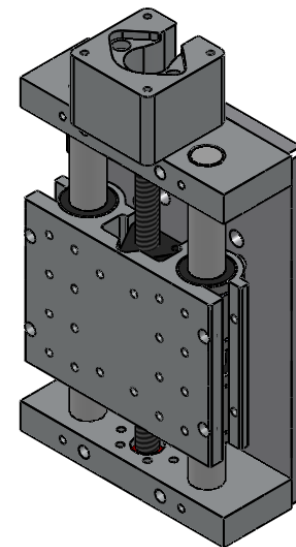

UNLESS OTHERWISE SPECIFIED:  
 DIMENSIONS ARE IN INCHES  
 FILLETS AND ROUNDS R  
 HOLES THROUGH ALL

INTERPRET GEOMETRIC TOLERANCING PER:  
 MATERIAL  
 FINISH  
 DO NOT SCALE DRAWING

	NAME	DATE
DRAWN		
CHECKED		
ENG APPR.		
MFG APPR.		
Q.A.		
COMMENTS:		

<b>VELOX CNC</b>		
TITLE:		
<b>ZA-300QR</b>		
SIZE	DWG. NO.	REV
<b>A</b>	Z-Axis Master	<b>1</b>
SCALE: 1:4	WEIGHT:	SHEET 2 OF 19

REVISIONS				
ZONE	REV.	DESCRIPTION	DATE	APPROVED
	1	3" TRAVEL	8/8/12	RL

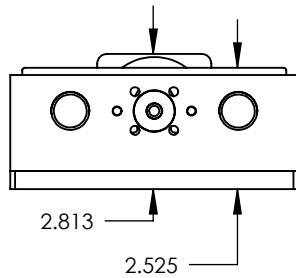
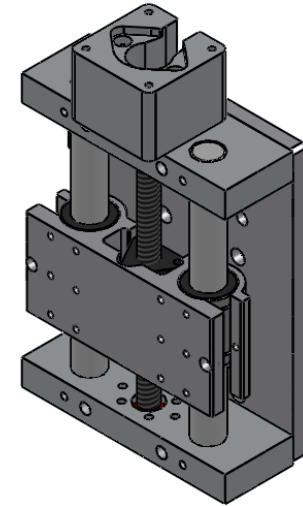
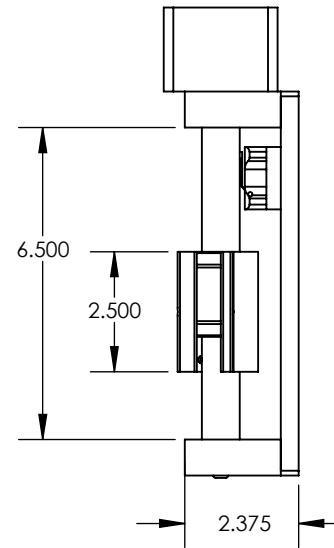
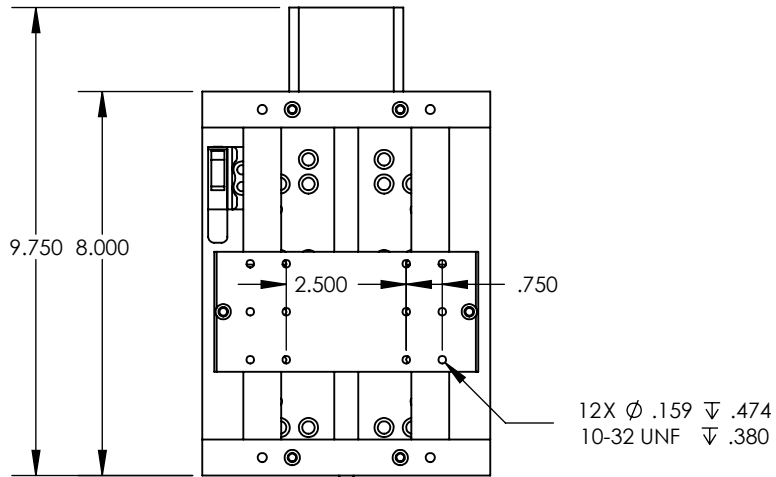
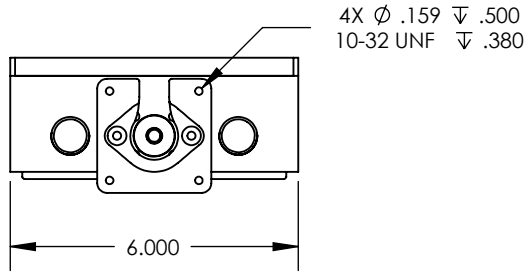

UNLESS OTHERWISE SPECIFIED:  
 DIMENSIONS ARE IN INCHES  
 FILLETS AND ROUNDS R  
 HOLES THROUGH ALL  
 INTERPRET GEOMETRIC TOLERANCING PER:  
 MATERIAL  
 FINISH  
 DO NOT SCALE DRAWING

	NAME	DATE
DRAWN		
CHECKED		
ENG APPR.		
MFG APPR.		
Q.A.		
COMMENTS:		

<b>VELOX CNC</b>		
TITLE:		
<b>ZA-300DR</b>		
SIZE	DWG. NO.	REV
<b>A</b>	Z-Axis Master	<b>1</b>
SCALE: 1:4	WEIGHT:	SHEET 3 OF 19

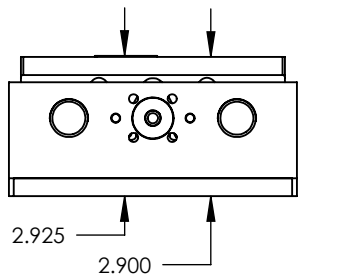
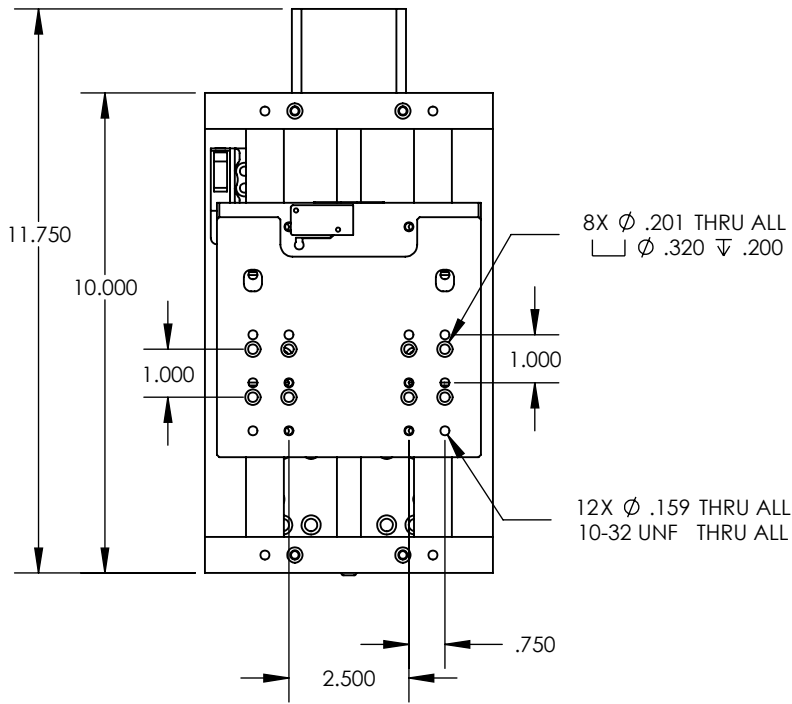
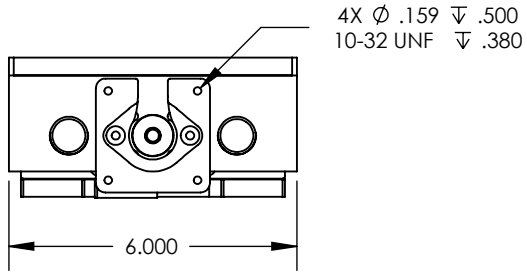

REVISIONS				
ZONE	REV.	DESCRIPTION	DATE	APPROVED
	1	3.5" TRAVEL	8/8/12	RL

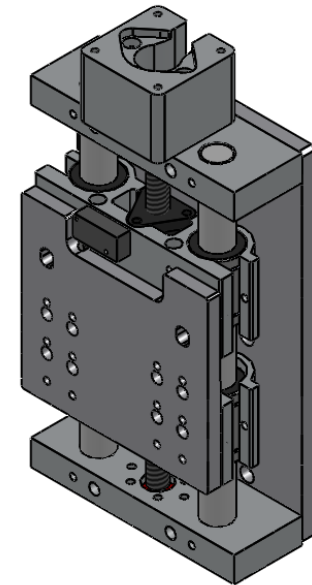
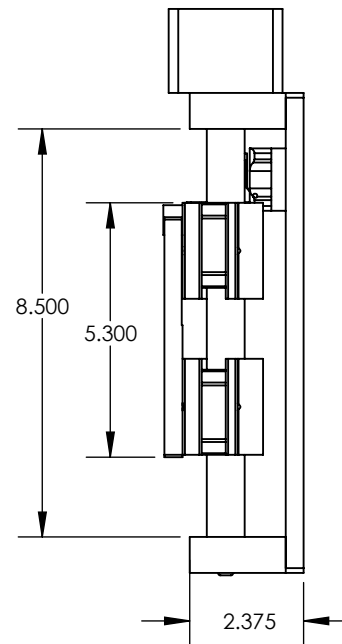

UNLESS OTHERWISE SPECIFIED:  
 DIMENSIONS ARE IN INCHES  
 FILLETS AND ROUNDS R  
 HOLES THROUGH ALL  
 INTERPRET GEOMETRIC TOLERANCING PER:  
 MATERIAL  
 FINISH  
 DO NOT SCALE DRAWING

	NAME	DATE
DRAWN		
CHECKED		
ENG APPR.		
MFG APPR.		
Q.A.		
COMMENTS:		

<b>VELOX CNC</b>		
TITLE:		
<b>ZA-350P</b>		
SIZE	DWG. NO.	REV
<b>A</b>	Z-Axis Master	<b>1</b>
SCALE: 1:4	WEIGHT:	SHEET 4 OF 19