

REVISIONS				
ZONE	REV.	DESCRIPTION	DATE	APPROVED
	1	5" TRAVEL	8/8/12	RL



UNLESS OTHERWISE SPECIFIED:
 DIMENSIONS ARE IN INCHES
 FILLETS AND ROUNDS R
 HOLES THROUGH ALL
 INTERPRET GEOMETRIC TOLERANCING PER:
 MATERIAL
 FINISH
 DO NOT SCALE DRAWING

	NAME	DATE
DRAWN		
CHECKED		
ENG APPR.		
MFG APPR.		
Q.A.		
COMMENTS:		

VELOX CNC		
TITLE:		
ZA-500QR		
SIZE	DWG. NO.	REV
A	Z-Axis Master	1
SCALE: 1:4	WEIGHT:	SHEET 8 OF 19

REVISIONS				
ZONE	REV.	DESCRIPTION	DATE	APPROVED
	1	5" TRAVEL	8/8/12	RL

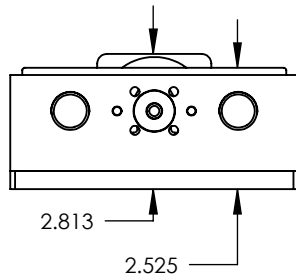
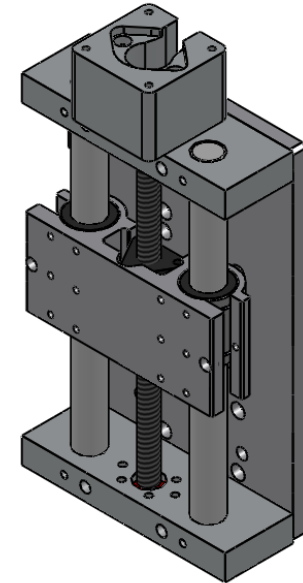
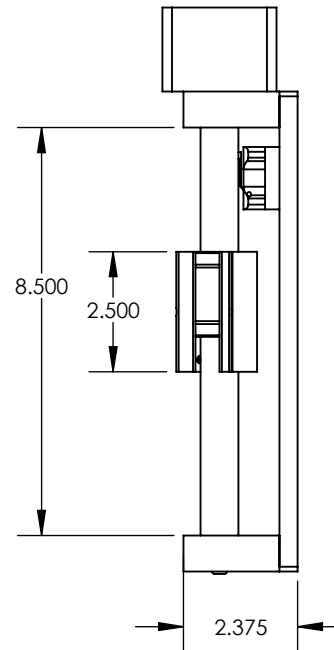
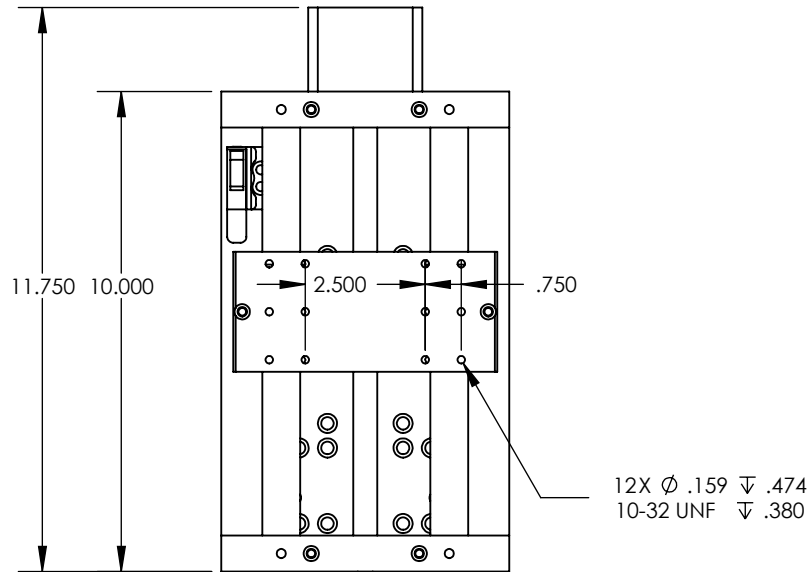
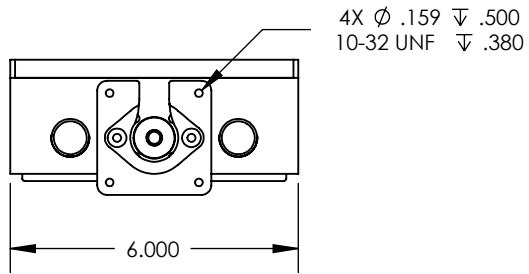

UNLESS OTHERWISE SPECIFIED:
 DIMENSIONS ARE IN INCHES
 FILLETS AND ROUNDS R
 HOLES THROUGH ALL
 INTERPRET GEOMETRIC TOLERANCING PER:
 MATERIAL
 FINISH
 DO NOT SCALE DRAWING

	NAME	DATE
DRAWN		
CHECKED		
ENG APPR.		
MFG APPR.		
Q.A.		
COMMENTS:		

VELOX CNC		
TITLE:		
ZA-500DR		
SIZE	DWG. NO.	REV
A	Z-Axis Master	1
SCALE: 1:4	WEIGHT:	SHEET 9 OF 19

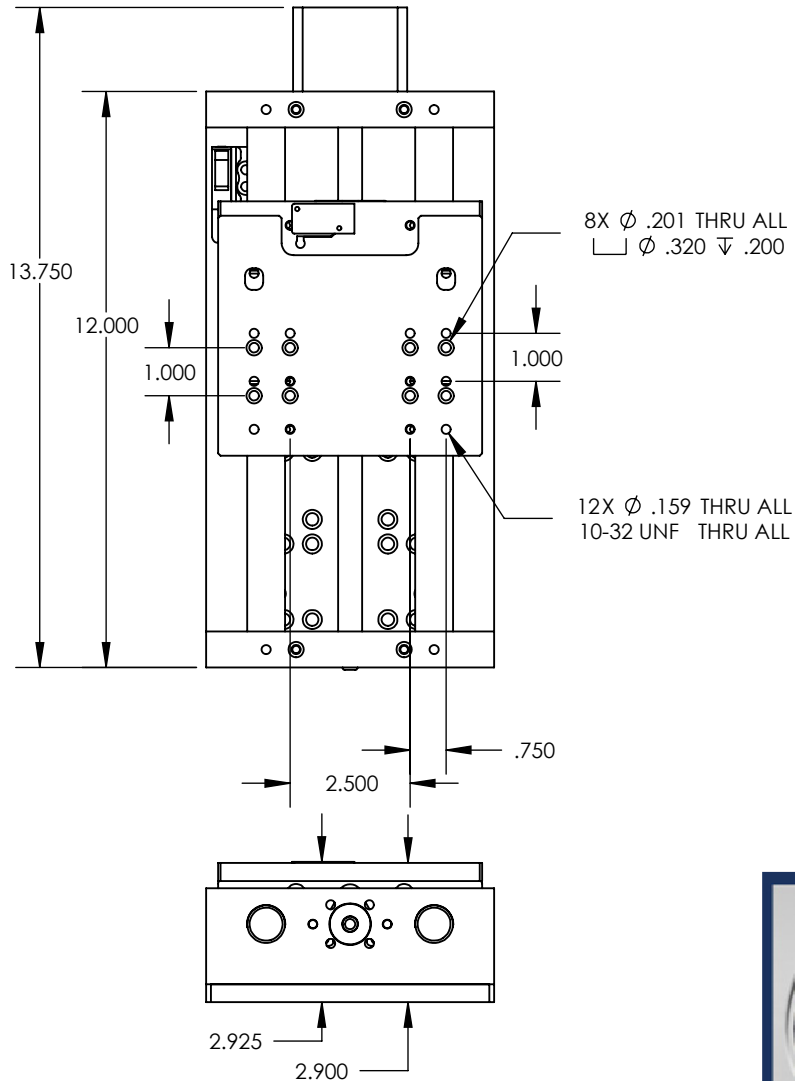
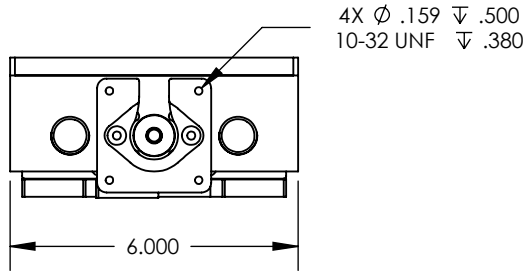

REVISIONS				
ZONE	REV.	DESCRIPTION	DATE	APPROVED
	1	5.5" TRAVEL	8/8/12	RL

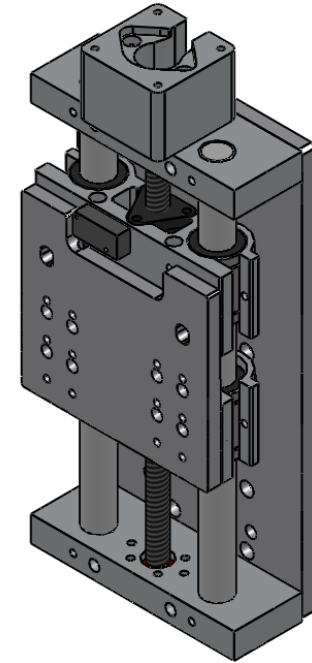
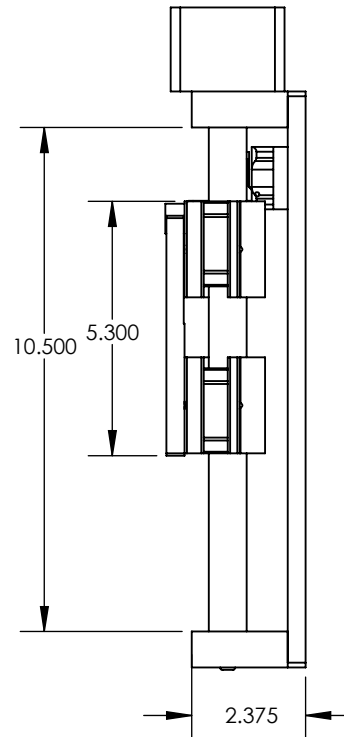

UNLESS OTHERWISE SPECIFIED:
DIMENSIONS ARE IN INCHES
FILLETS AND ROUNDS R
HOLES THROUGH ALL
INTERPRET GEOMETRIC TOLERANCING PER:
MATERIAL
FINISH
DO NOT SCALE DRAWING

	NAME	DATE
DRAWN		
CHECKED		
ENG APPR.		
MFG APPR.		
Q.A.		
COMMENTS:		

VELOX CNC		
TITLE:		
ZA-550P		
SIZE	DWG. NO.	REV
A	Z-Axis Master	1
SCALE: 1:4	WEIGHT:	SHEET 10 OF 19